

# EVER❄️CHILL

## 16 CU. FT. FRENCH DOOR REFRIGERATOR INSTRUCTION MANUAL

MFR No.: BCD-455WTE-B-04H

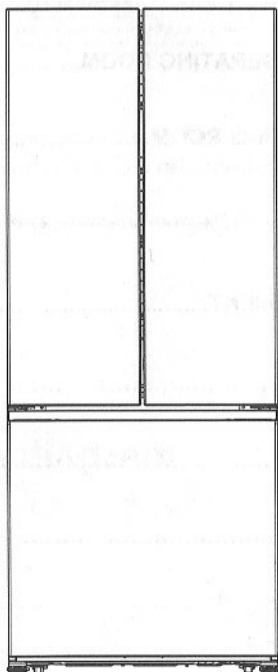

To ensure proper use of this appliance and your safety, please read the following instructions completely before operating this appliance.

# TABLE OF CONTENTS

FEATURES AND PARTS ..... 3

IMPORTANT SAFETY INSTRUCTIONS ..... 4

INSTALLATION INSTRUCTION ..... 4

OPERATIONAL GUIDANCE OF DISPLAY ..... 5

THE SETTING OF THE REFRIGERATING ROOM ..... 6

THE SETTING OF THE FREEZING ROOM ..... 6

THE SETTING OF ON/OFF ..... 6

LIGHTING AND ITS REPLACEMENT ..... 7

CARE & MAINTENANCE ..... 8

INSTALLATION ..... 9

TROUBLESHOOTING GUIDE ..... 10

## Usage note

### Do not remove the back panel during installation.

1. In order for normal use, the connection must be reliable. Besides the power source proper connection, the wire of the unit and outer wire must meet the following requirement:

Wire size	The max length (Feet)
14 AWG	3.2 Feet
13 AWG	8 Feet
12 AWG	13 Feet
10 AWG	20 Feet
8 AWG	33 Feet
6 AWG	50 Feet

Remarks: 14 AWG wire is not recommended. 12 AWG wire or Larger is recommended. This DC unit is not equipped with a power source. Please purchase a power source from an authorized dealer.

2. When using an adaptor or converter AC to DC, No DC power supply is recommended. The operation of the DC refrigerator is also dependent on a good, clean ground connections.
3. It is recommended that only authorized or qualified professionals perform repair services on unit.

## Wire connection diagram

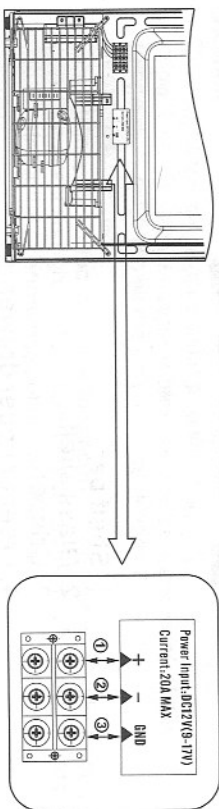

1. Connect ① terminal with Positive pole of 12V DC.
2. Connect ② terminal with Negative pole of 12V DC.
3. If the unit is installed in an RV, The ③ GND terminal should be connected to a metal portion of the RV.

# FEATURES AND PARTS

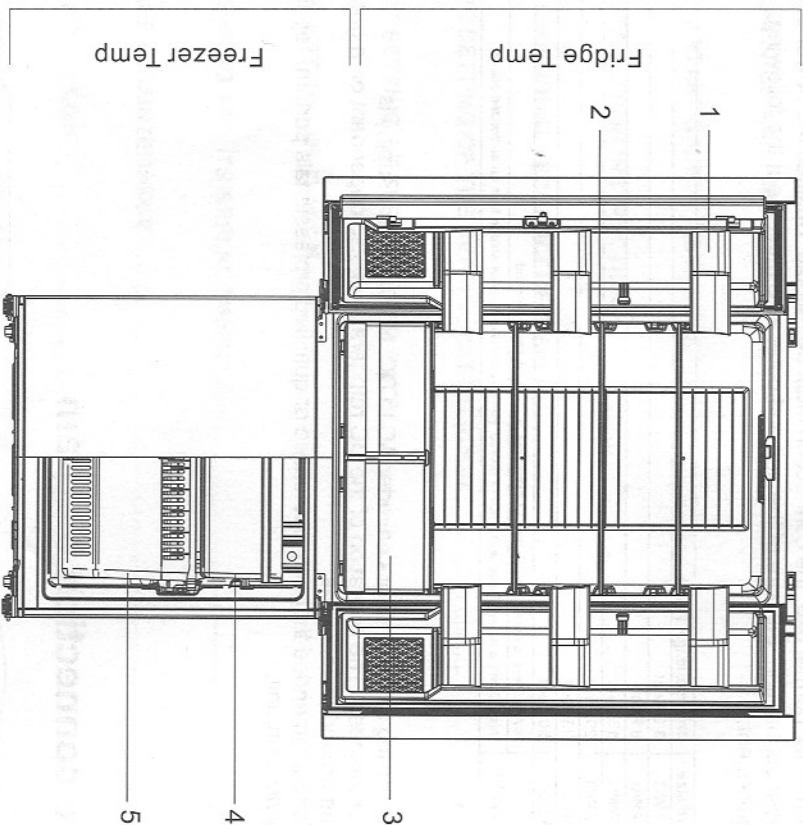

1. Shelf bar
2. Glass shelf
3. Crisper
4. Freezer upper drawer
5. Freezer lower drawer

# Important Safety Instructions



**WARNING** To reduce the risk of fire, electrical shock, or injury follow these basic precautions when using your refrigerator.

- **DANGER:** Risk of child entrapment. To avoid the possibility of child entrapment, please take the following precautions before you dispose of your refrigerator.
  - Remove all doors.
  - Leave shelves in place so children may not easily climb in.
  - Never allow children to play with, operate, or crawl inside the refrigerator.
- Do not store or use gasoline or any flammable vapors and liquids in the vicinity of this refrigerator.
- All refrigeration products contain refrigerants, which under the guidelines of federal law must be removed before disposal. It is the consumer's responsibility to comply with federal and local regulations when disposing of this product.
- This appliance is not intended for use by persons (including children) with reduced physical, sensory or mental capabilities, or lack of experience and knowledge, unless they have been given supervision or instruction concerning use of the appliance by a person responsible for their safety.
- Children should be supervised to ensure that they do not play with the appliance.

## Installation Instructions

### Before Using Your Refrigerator

- Remove the exterior and interior packing.
- Before connecting the refrigerator to the power source, let it stand upright for approximately 4 hours. This will reduce the possibility of a malfunction in the cooling system from improper handling during transportation.
- Clean the interior surface with lukewarm water using a soft cloth. (Cleaning instructions on page 7)

### Location

- This appliance is designed to be free standing only.
- Allow 1 inches clearance space between the back and sides of the refrigerator, which allows the proper air ventilation.
- **Avoid Installation:**
  - On weak surfaces unable to support refrigerator when fully loaded.
  - In direct sunlight and sources of heat (stove, heater, radiator, etc.) will hinder the performances of this appliance.

### Installing Your Refrigerator

- Adjust the leveling feet to keep the refrigerator level.

## Electrical Connection



**Improper use of the grounded plug can result in the risk of electrical shock. If the power cord is damaged, have it replaced by an authorized service center.**

This refrigerator should be properly grounded for your safety.

This refrigerator requires a standard 9-17V, electricity  $\geq 15A$ . Direct connection with AC power source is forbidden.

Do not connect this unit to an AC power source.

To prevent accidental injury, the electrical cord should be secured behind the refrigerator, and not be left exposed or dangling.

## OPERATIONAL GUIDANCE OF DISPLAY

The below picture is a schematic diagram of an electronic display.

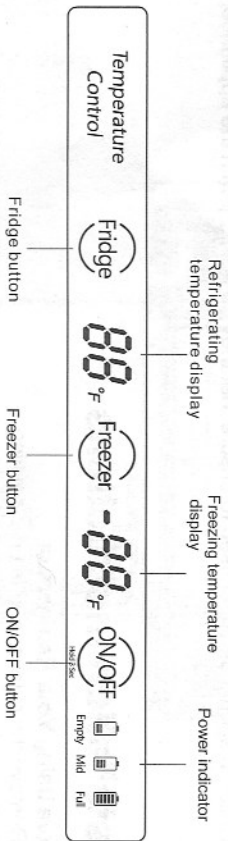

### Button instruction

- ❖ "Fridge" button: adjust the setting temperature of refrigerating room (press down is effective).
- ❖ "Freezer" button: adjust the setting temperature of freezing room (press down is effective).
- ❖ "ON/OFF" button: Press and hold the ON/OFF button for 3S to enter shutdown or power-on state.

## THE SETTING OF THE REFRIGERATING ROOM

- ❖ The LED display turns bright when the door is open. Push the "Fridge" button. The buzzer rings. Then the refrigerating room turns into the setting condition. The temperature pattern turns flash and the temperature of the refrigerating room increases 1. The temperature will recycle from "33" to "45". When the temperature turns "45", push the "Fridge" button, then the refrigerator turns into the condition of pre-closing the refrigerating room and the LED display turns "\_\_\_\_" with flashing light.

## THE SETTING OF THE FREEZING ROOM

- ❖ The LED display turns bright when the door is open. Push the "Freezer" button. The buzzer rings. Then the freezing room turns into the setting condition. The temperature turns flash and the temperature of the freezing room increases 1. It will recycle from "5" to "-3".
- Warning:** The temperature will be set successfully and the flash will disappear if stop setting over 5 seconds.

## THE SETTING OF ON/OFF

- ❖ Press and hold ON/OFF key for 3s in power-on state to enter power-off state, all loads are turned off, the display panel shows "—" in the refrigeration and freezing temperature display area, and the power is displayed normally; in power-off state, press the ON/OFF key for 3s to enter power-on state, and refrigerator is operating normally.

## POWER INDICATOR

- ❖ The power indicator is displayed on the display panel. When the input voltage is greater than 12.5V, the Full icon light is on. When the input voltage is less than 12.5V and greater than 11.5V, the Mid icon light is on.

## LIGHTING AND ITS REPLACEMENT

- ❖ When the door of refrigerating room opens, the LED light turns on.
- ❖ When the lighting is damaged, please remove the lampshade first and then replace the LED lighting.

❖ The specific operations are shown in the following diagram:

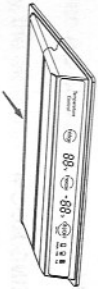

1. Please move the lampshade and the thermostat out 3-5mm in the direction of the arrow.

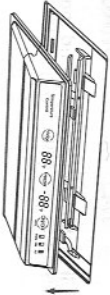

2. Take out the lamp shade and thermostat downwards, the arrow.



3. Pull the connection terminal, use the screwdriver to remove the LED light board and replace it.

**Note:** If the LED lamp is abnormal, it should be replaced by professionals. Do not take dismantling and replace it privately in order to avoid damage.

## Care and Maintenance

### Cleaning Your Refrigerator

- Clean interior and parts with a cloth soaked in lukewarm water and baking soda solution. A solution of 2 tablespoons baking soda to a quart of water will clean and neutralize odors. Rinse and wipe dry.
- Be sure to keep the door gasket (seal) clean to keep the unit running efficiently.
- The outside of the refrigerator should be cleaned with a warm damp cloth and mild detergent. Do not use harsh or abrasive cleaners.
- Never clean refrigerator parts with flammable fluids. The fumes can create a fire hazard.

### Vacation Time

- For long vacations, remove all food.
- Clean the interior and leave doors open to avoid possible odor or mold formation.
- Use extreme caution in the case of children. The unit should not be accessible to child's play.

### Moving Your Refrigerator

- Disconnect the power source.
- Remove all the food and securely tape down all loose items such as shelves, drawers, and doors.
- Be sure the refrigerator stays in the upright position during transportation.

### Energy Saving Tips

- The refrigerator should be located in the coolest area of the room, away from heat producing appliances or heating ducts, and out of the direct sunlight.
- Let hot foods cool to room temperature before placing in the refrigerator.
- Be sure to wrap foods properly, and wipe containers dry before placing them in the refrigerator. This cuts down on frost build-up inside the refrigerator.
- Organize and label food to reduce door openings and extended searches

## Installation

Install the refrigerator in a convenient location away from extreme heat and cold. Allow sufficient clearance between the refrigerator and side wall so the door(s) will open without obstruction. Refrigerator is not designed for recessed installation. Select a space with strong level floor. Allow 1 inches of space between the refrigerator's side and the wall. The appliance must be correctly connected to the power supply.

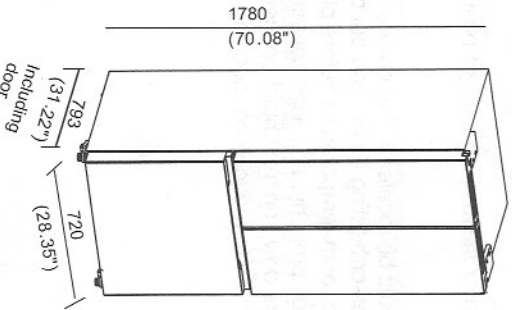
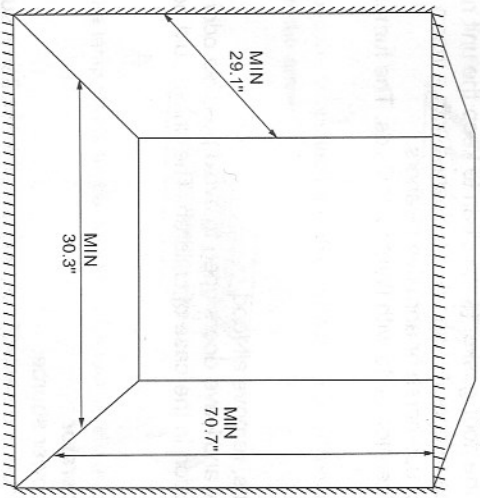

- Note: The door should protrude at least 1" beyond the surrounding cabinets.

## Troubleshooting Guide

You can solve many common refrigerator problems easily, saving you the cost of a possible service call. Try the suggestions below to see if you can solve the problem before calling for service.

<b>Problem</b>	<b>Possible Causes</b>
<b>Refrigerator does not operate</b>	<ul style="list-style-type: none"> <li>• Refrigerator is unplugged.</li> <li>• The circuit breaker is tripped/ fuse blown.</li> </ul>
<b>Compressor turns on and off</b>	<ul style="list-style-type: none"> <li>• The room temperature is warmer than normal</li> <li>• Door is left open or is frequently opened.</li> <li>• The refrigerator does not have the correct clearances.</li> <li>• The refrigerator has recently been disconnected for a period of time.</li> </ul>
<b>Refrigerator compartments are too warm</b>	<ul style="list-style-type: none"> <li>• Temperature control is not set correctly.</li> <li>• Door is left open or is frequently opened.</li> <li>• The door gasket does not seal properly.</li> <li>• A large amount of warm or hot food was stored recently. Wait for the refrigerator to reach its selected temperature.</li> <li>• The refrigerator has recently been disconnected for a period of time.</li> </ul>
<b>Vibrating or rattling (slight vibration is normal)</b>	<ul style="list-style-type: none"> <li>• Leveling legs need adjusting</li> <li>• Refrigerator is placed on an uneven or weak surface.</li> <li>• The refrigerator is touching the wall. Re-level the refrigerator and move it away from the wall.</li> </ul>
<b>Temperature of external refrigerator surface is warm</b>	<ul style="list-style-type: none"> <li>• The exterior refrigerator walls can be as much as 30°F warmer than room temperature.</li> <li>• This is normal while the compressor works to transfer heat from inside the refrigerator cabinet</li> </ul>
<b>Moisture collects inside the refrigerator</b>	<ul style="list-style-type: none"> <li>• Door is left open or is frequently opened.</li> </ul>
<b>Moisture forms on outside of refrigerator</b>	<ul style="list-style-type: none"> <li>• Is normal in hot and humid weather. Air carries moisture into the refrigerator when doors are opened.</li> </ul>
<b>Bubbling or gurgling sounds (like boiling water)</b>	<ul style="list-style-type: none"> <li>• This is the normal sound of refrigerant (used to cool refrigerator) circulating throughout the system.</li> </ul>
<b>Popping or cracking sounds when compressor comes on</b>	<ul style="list-style-type: none"> <li>• This is normal. Metal parts undergo expansion and contraction, like hot water pipes. The sound will level off or disappear as refrigerator runs.</li> </ul>
<b>The door will not close properly</b>	<ul style="list-style-type: none"> <li>• The refrigerator is not on a level surface.</li> <li>• The gasket is dirty.</li> <li>• The storage basket is out of position.</li> </ul>