

Installation Instruction

1. Mount to car roof rack.

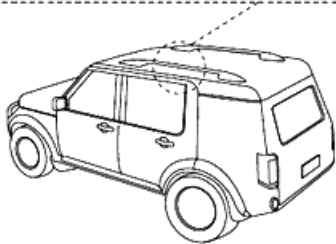

2. Open the protective cover and slide the M8*25 bolts into the mounting rails of the tent.

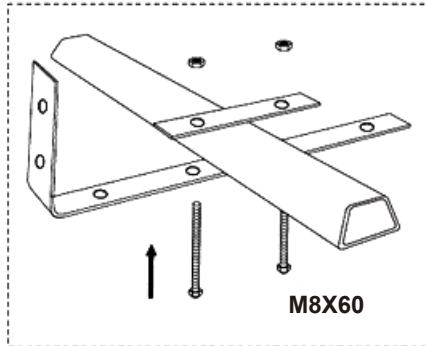
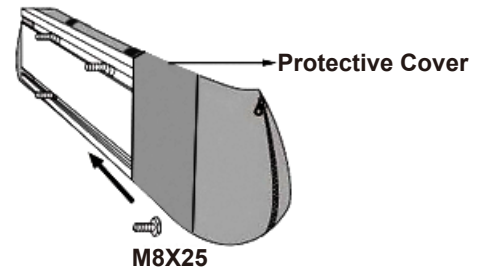

3. Raise the tent and align the short part of the L-bracket, tighten with the provided bolts.

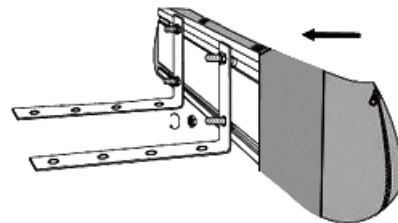

4. Release the zipper on the PVC protective bag, then release the buckle securing the side curtain.

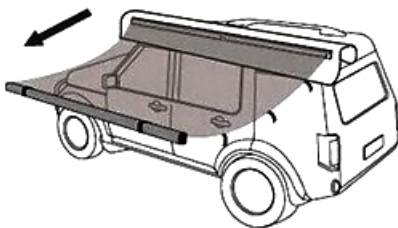

5. Extend the tent to full length, release the floor bar to the desired height, and tighten the centrifugal parts.

Loosen the extension rod of the side tent, then insert it into the mounting hole and tighten the centrifugal parts.

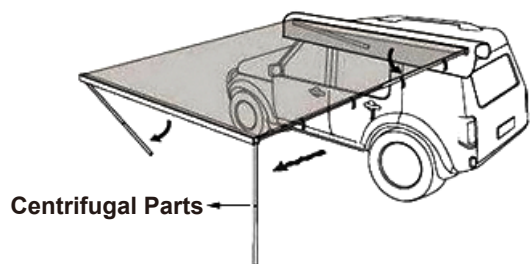

6. Use Velcro to fix the tarp to the extension pole. Use wind rope and ground nails to fix on the ground to prevent wind-blowing.

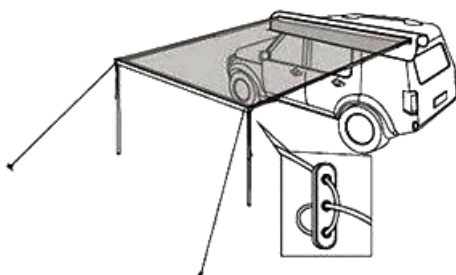

CAUTION:

Check all nuts and bolts regularly.
Put a soft cloth or cushion over the installation area to avoid any potential damage to your car during installation.
Install L-brackets on rails, roof racks, or rails.