

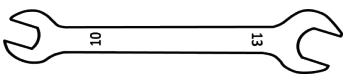

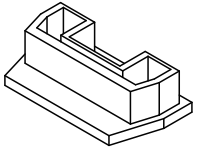
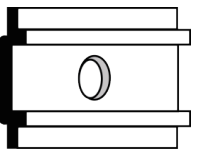

ROOFTOP TENT USER MANUAL

Please read this manual carefully before installation, and retain it for future reference.

PARTS LIST

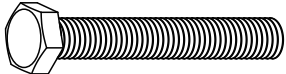
Item	Description	Qty	
1	Metric Wrench 10/13 mm	2	
2	Track plug	4	
3	Aluminum Slide Plate	8	
4	Stainless Steel Mounting Plate	4	
5	55mm Stainless Steel M8 Bolt	8	
6	M8 Self-Locking Nut	8	

OPERATING INSTRUCTIONS

FITTING TO THE ROOF RACK OR CROSSBAR :

1. With assistance, carefully lift your rooftop tent and place it onto the top of the roof racks or crossbars of your vehicle and ensure that the mounting channels are perpendicular to the racks or bars they will be mounted to, and that the tent is centered on the roof rack.



2. Slide the bolts and channel sliders into the mounting channels. You will need to lift your rooftop tent side, so as to have one of the bolts on the inside of the roof rack. Repeat the same steps for the remaining three sides.

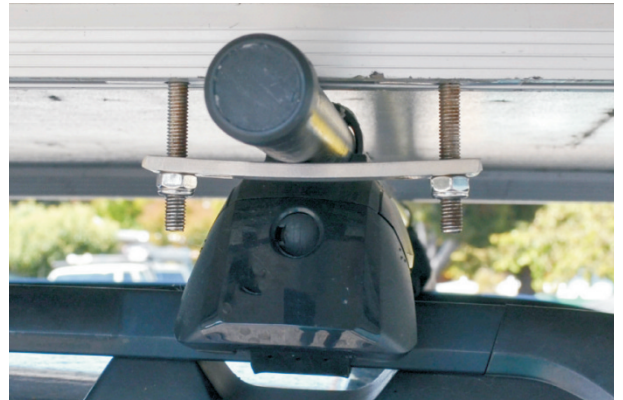

3. Use a steel mounting plate and nuts to secure the bolts at each of the four corners where the rack and mounting channel cross. Tighten all eight bolts securely. It is important that you check all the mounting bolts and brackets periodically to ensure they are securely fastened to your base and roof rack or crossbars. Insert the rubber end caps into the ends of the mounting channel (this may require light taps from a hammer) after ensuring the tent is positioned correctly, and all eight bolts are tightened securely.



OPERATING INSTRUCTIONS

SET UP YOUR ROOFTOP TENT & LADDER OPERATION

- 1 . Unlock the fastening buckle and release the roof.
- 2 . With your hand push up the hard shell, just give the tent a light push, then the gas struts will open the rest of the tent on its own.
- 3 . Once the top has fully opened, reach up and grab the base of the ladder. Undo the velcro strap and extend the ladder. When opening the ladder, withdraw all rungs and open each rung from the bottom to the top, each rung must be locked. If the ladder is too long, you can push the top few rungs up until they are locked into place.
- 4 . Place the ladder at an approximate 70° angle, and make sure the base of the ladder is level and on solid terrain. If not in a secure place move your vehicle to a more even terrain. The ladder should NOT be over-extended. It will not give the support that it needs to if not set up properly.

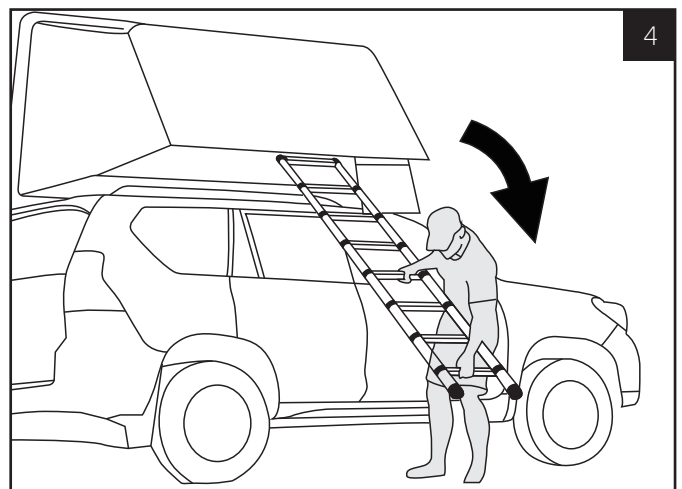
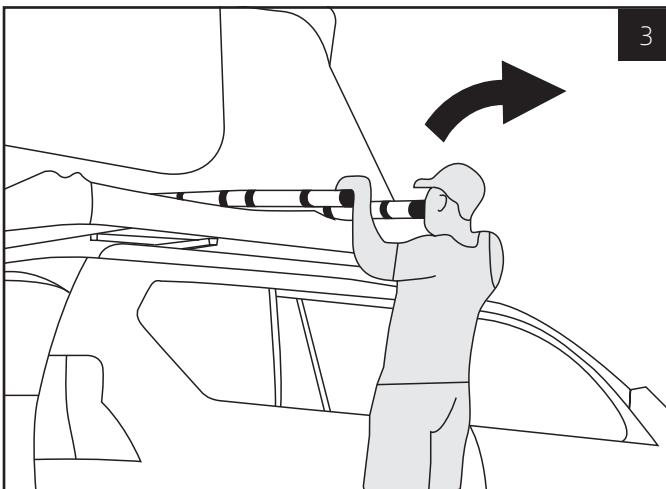
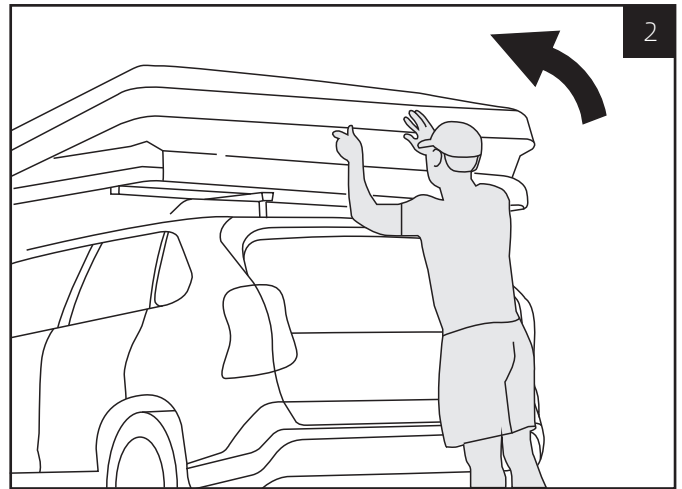
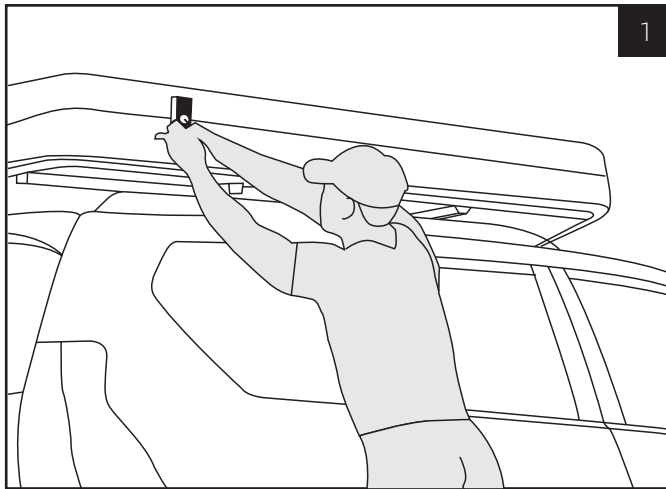

NOTE: Before going up the ladder, check to see if each rung is secure. Take time to adjust each one to be certain. You only have to depress both buttons on the bottom rung to lower the ladder.

SETTING UP THE RAIN FLY

The rainfly should be erected using the window rods. Climb half-way up the ladder, take one rod, and insert the straight end into one of the holes located at the bottom of the tent. The hook at the top end of the rod should be facing down.

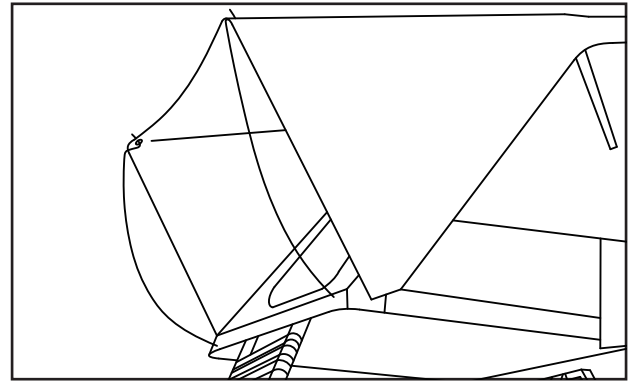

CLOSING THE HARD SHELL

1. Remove rainfly rods from the canopy. Retract the ladder, starting with the bottom steps. Make sure to depress the buttons with your thumbs and be careful not to get your hand caught between rungs. Then secure the ladder with included strap.
2. Using the ladder, push the tent base up and then push both the base and the ladder into the tent.
3. Grab the black strap attached to the top of the shell. Pull down on the strap to close the hard shell.
4. Gently push in the excess material into the tent on the front, back and side. Then secure your tent.

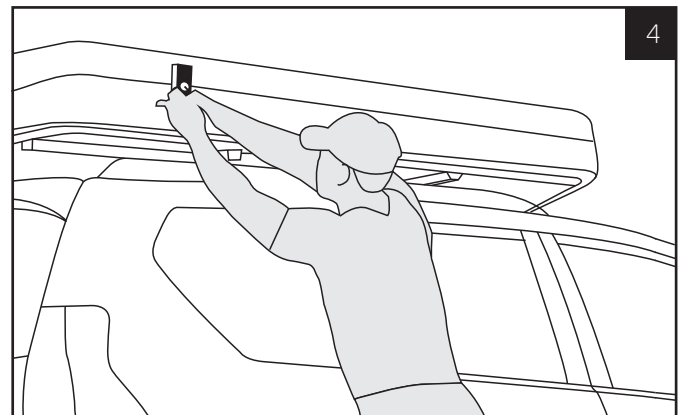
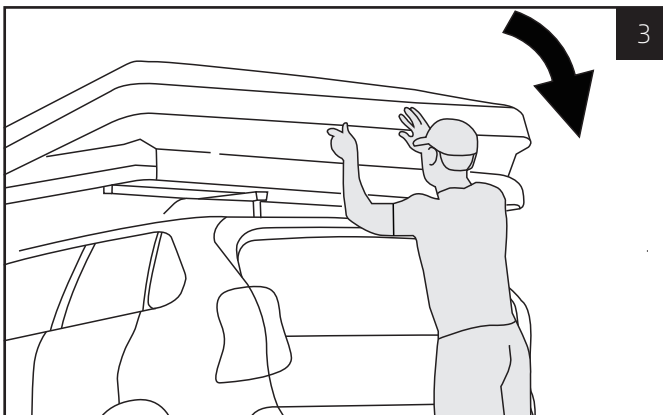
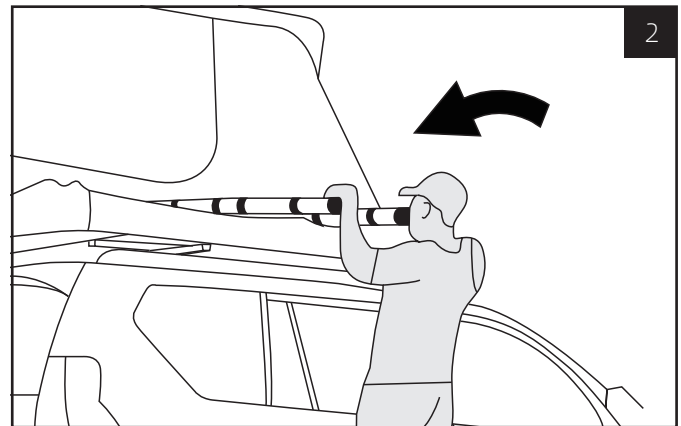
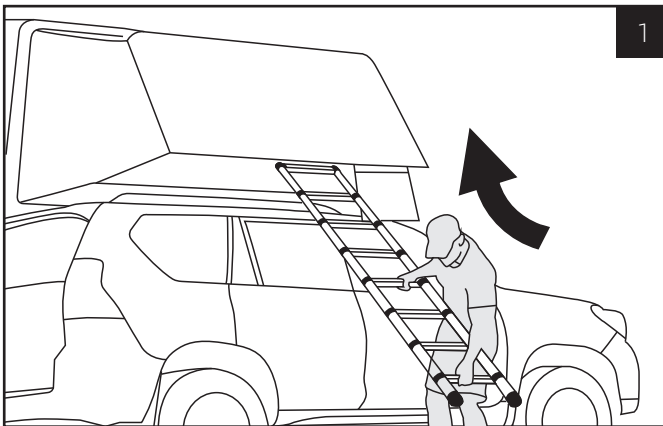

NOTE: ALWAYS make sure that the hard shell is completely closed and the straps are securely fastened before driving. If you find it hard to completely close the tent, it may be due to left over canopy.