

Microwave Oven

INSTRUCTION MANUAL

Model:EC028AD7-S1R
Kit No.:KITB2801S

Read these instructions carefully before using your microwave oven, and keep it carefully.

If you follow the instructions, your oven will provide you with many years of good service.

SAVE THESE INSTRUCTIONS CAREFULLY

PRECAUTIONS TO AVOID POSSIBLE EXPOSURE TO EXCESSIVE MICROWAVE ENERGY

- (a) Do not attempt to operate this oven with the door open since open door operation can result in harmful exposure to microwave energy.
It is important not to defeat or tamper with the safety interlocks.
- (b) Do not place any object between the oven front face and the door or allows soil or cleaner residue to accumulate on sealing surfaces.
- (c) Do not operate the oven if it is damaged. It is particularly important that the oven door close properly and that there is no damage to the:
 - (1) DOOR (bent)
 - (2) HINGES AND LATCHES (broken or loosened)
 - (3) DOOR SEALS AND SEALING SURFACES
- (d) The oven should not be adjusted or repaired by anyone except properly qualified service personnel.

Specifications

Model:	EC028KD7-AF, EC028BMR-AF
Rated Voltage:	120V~ 60Hz
Rated Input Power(Microwave):	1500W
Rated Output Power(Microwave):	1000W
Rated Input Power(Grill):	1150W
Rated Input Power(Convection):	1450W
Oven Capacity:	1.0 Cu.Ft
Turntable Diameter:	12.4 inch
External Dimensions:	20.47 X18.3 X 14.76 inch (523X475X375mm)
Net Weight:	Approx.45.41Lbs (20.06kg)

IMPORTANT SAFETY INSTRUCTIONS

When using electrical appliances basic safety precautions should be followed, including the following:

WARNING - To reduce the risk of burns, electric shock, fire, injury to persons or exposure to excessive microwave energy:

1. Read all instructions before using the appliance.
2. Read and follow the specific: "PRECAUTIONS TO AVOID POSSIBLE EXPOSURE TO EXCESSIVE MICROWAVE ENERGY" found on page 2.
3. This appliance must be grounded. Connect only to properly grounded outlet. See "GROUNDING INSTRUCTIONS" found on page 5.
4. Install or locate this appliance only in accordance with the provided installation instructions.
5. Some products such as whole eggs and sealed containers - for example, closed glass jars - are able to explode and should not be heated in this oven.
6. Use this appliance only for its intended use as described in the manual. Do not use corrosive chemicals or vapors in this appliance. This type of oven is specifically designed to heat, cook or dry food. It is not designed for industrial or laboratory use.
7. "HOT CONTENTS CAN CAUSE SEVERE BURNS. DO NOT ALLOW CHILDREN TO USE THE MICROWAVE. Use caution when removing hot items."
8. Do not operate this appliance if it has a damaged cord or plug, if it is not working properly, or if it has been damaged or dropped.
9. This appliance should be serviced only by qualified service personnel. Contact nearest authorized service facility for examination, repair, or adjustment.
10. Do not cover or block any openings on the appliance.
11. Do not store this appliance outdoors. Do not use this product near water - for example, near a kitchen sink, in a wet basement, near a swimming pool, or similar location.
12. Do not immerse cord or plug in water.
13. Keep cord away from heated surface.
14. Do not let cord hang over edge of table or counter.
15. When cleaning surfaces of door and oven that comes together on closing the door, use only mild, nonabrasive soaps, or detergent applied with a sponge or soft cloth.
16. To reduce the risk of fire in the oven cavity:
 - 1). Do not overcook food. Carefully attend appliance when paper, plastic, or other combustible materials are placed inside the oven to facilitate cooking.
 - 2). Remove wire twist-ties from paper or plastic bag before placing bag in oven.
 - 3). If material inside of the oven ignite, keep oven door closed, turn oven off, and disconnect the power cord, or shut off power at the fuse or circuit breaker panel.
 - 4). Do not use the cavity for storage purposes. Do not leave paper products, cooking utensils, or food in the cavity when not in use.

17. Liquids, such as water, coffee, or tea are able to be overheated beyond the boiling point without appearing to be boiling. Visible bubbling or boiling when the container is removed from the microwave oven is not always present.
THIS COULD RESULT IN VERY HOT LIQUID SUDDENLY BOILING OVER WHEN THE CONTAINER IS DISTURBED OR A UTENSIL IS INSERTED INTO THE LIQUID.
To reduce the risk of injury to persons:
- 1) Do not overheat the liquid.
 - 2) Stir the liquid both before and halfway through heating it.
 - 3) Do not use straight-sided containers with narrow necks.
 - 4) After heating, allow the container to stand in the microwave oven for a short time before removing the container.
 - 5) Use extreme care when inserting a spoon or other utensil into the container.
18. Oversized food or oversized metal utensils should not be inserted in a microwave/toaster oven as they may create a fire or risk of electric shock.
19. Do not clean with metal scouring pads. Pieces can burn off the pad and touch electrical parts involving a risk of electric shock.
20. Do not use paper products when appliance is operated in the toaster mode.
21. Do not store any materials, other than manufacturer's recommended accessories, in this oven when not in use.
22. Do not cover racks or any other part of the oven with metal foil. This will cause overheating of the oven.

SAVE THESE INSTRUCTIONS

GROUNDING INSTRUCTIONS

This appliance must be grounded. In the event of an electrical short circuit, grounding reduces the risk of electric shock by providing an escape wire for the electric current. This appliance is equipped with a cord having a grounding wire with a grounding plug. The plug must be plugged into an outlet that is properly installed and grounded.

WARNING - Improper use of the grounding can result in a risk of electric shock. Consult a qualified electrician or serviceman if the grounding instructions are not completely understood, or if doubt exists as to whether the appliance is properly grounded. If it is necessary to use an extension cord, use only a 3-wire extension cord that has a 3-blade grounded plug, and 3-slot receptacle that will accept the plug on the appliance. The marked rating of the extension cord shall be equal to or greater than the electrical rating of the appliance.

DANGER - Electric Shock Hazard

Touching some of the internal components can cause serious personal injury or death. Do not disassemble this appliance.

WARNING - Electric Shock Hazard

Improper use of the grounding can result in electric shock. Do not plug into an outlet until appliance is properly installed and grounded.

1. A short power-supply cord is provided to reduce the risks resulting from becoming entangled in or tripping over a longer cord.
2. Longer cord sets or extension cords are available and may be used if care is exercised in their use.
3. If a long cord or extension cord is used:
 - 1) The marked electrical rating of the cord set or extension cord should be at least as great as the electrical rating of the appliance.
 - 2) The extension cord must be a grounding-type 3-wire cord.
 - 3) The longer cord should be arranged so that it will not drape over the counter top or tabletop where it can be pulled on by children or tripped over unintentionally.

RADIO INTERFERENCE

1. Operation of the microwave oven may cause interference to your radio, TV or similar equipment.
2. When there is interference, it may be reduced or eliminated by taking the following measures:
 - 1) Clean door and sealing surface of the oven
 - 2) Reorient the receiving antenna of radio or television.
 - 3) Relocate the microwave oven with respect to the receiver.
 - 4) Move the microwave oven away from the receiver.
 - 5) Plug the microwave oven into a different outlet so that microwave oven and receiver are on different branch circuits.

This device complies with part 18 of the FCC Rules.

UTENSILS

CAUTION - Personal Injury Hazard

Tightly-closed utensils could explode. Closed containers should be opened and plastic pouches should be pierced before cooking.

See the instructions on "Materials you can use in microwave oven or to be avoided in microwave oven."

There may be certain non-metallic utensils that are not safe to use for microwaving. If in doubt, you can test the utensil in question following the procedure below.

Utensil Test:

1. Fill a microwave-safe container with 1 cup of cold water (250ml) along with the utensil in question.
2. Cook on maximum power for 1 minute.
3. Carefully feel the utensil. If the empty utensil is warm, do not use it for microwave cooking.
4. Do not exceed 1 minute cooking time.

Materials you can use in microwave oven

Utensils	Remarks
Browning dish	Follow manufacturer's instructions. The bottom of browning dish must be at least 3/16 inch (5mm) above the turntable. Incorrect usage may cause the turntable to break.
Dinnerware	Microwave-safe only. Follow manufacturer's instructions. Do not use cracked or chipped dishes.
Glass jars	Always remove lid. Use only to heat food until just warm. Most glass jars are not heat resistant and may break.
Glassware	Heat-resistant oven glassware only. Make sure there is no metallic trim. Do not use cracked or chipped dishes.
Oven cooking bags	Follow manufacturer's instructions. Do not close with metal tie. Make slits to allow steam to escape.
Paper plates and cups	Use for short-term cooking/warming only. Do not leave oven unattended while cooking.
Paper towels	Use to cover food for reheating and absorbing fat. Use with supervision for a short-term cooking only.
Parchment paper	Use as a cover to prevent splattering or a wrap for steaming.
Plastic	Microwave-safe only. Follow the manufacturer's instructions. Should be labeled "Microwave Safe". Some plastic containers soften, as the food inside gets hot. "Boiling bags" and tightly closed plastic bags should be slit, pierced or vented as directed by package.
Plastic wrap	Microwave-safe only. Use to cover food during cooking to retain moisture. Do not allow plastic wrap to touch food.
Thermometers	Microwave-safe only (meat and candy thermometers).
Wax paper	Use as a cover to prevent splattering and retain moisture.

Materials to be avoided in microwave oven

Utensils	Remarks
Aluminum tray	May cause arcing. Transfer food into microwave-safe dish.
Food carton with metal handle	May cause arcing. Transfer food into microwave-safe dish.
Metal or metal-trimmed utensils	Metal shields the food from microwave energy. Metal trim may cause arcing.
Metal twist ties	May cause arcing and could cause a fire in the oven.
Paper bags	May cause a fire in the oven.
Plastic foam	Plastic foam may melt or contaminate the liquid inside when exposed to high temperature.
Wood	Wood will dry out when used in the microwave oven and may split or crack.

NAMES OF OVEN PARTS AND ACCESSORIES

(In case of any differences between the appliance and the pictures in this manual, the product shall prevail.)

Remove the oven and all materials from the carton and oven cavity.
Your oven comes with the following accessories:

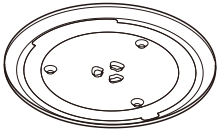

Glass Tray



Turntable Ring Assembly

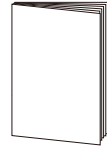

Instruction Manual

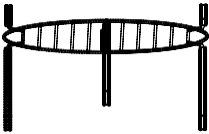

Grill Rack(Cannot be used in microwave function and must be placed on the grill tray)



Turntable Shaft



Grill tray(Cannot be used in microwave function and must be placed on the grill rack)

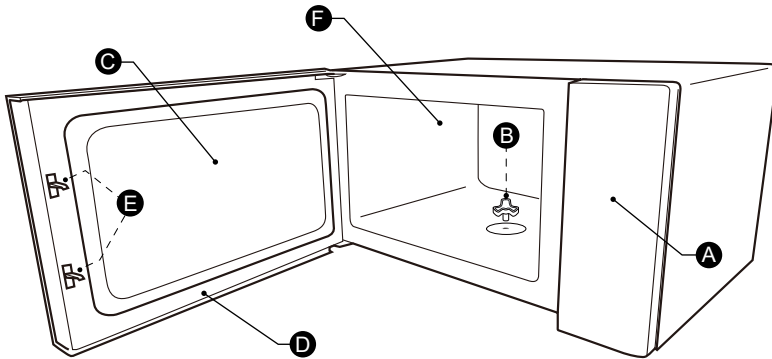

A) Control panel

B) Turntable shaft

C) Observation window

D) Door assembly

E) Safety interlock system

F) Oven cavity

TURNTABLE INSTALLATION

Cleaning the cooking compartment and putting the turntable in place. For new installations, make sure all packaging and shipping tape has been removed from the turntable shaft. Before using the appliance to prepare food for the first time, you will need to put the turntable in place correctly. You must clean the cooking compartment and accessories.

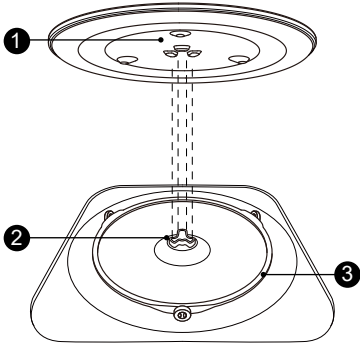

How to put the turntable in place:

1. Place the turntable ring assembly ③ into the recess in the cooking compartment.
2. Place the glass tray ① on the turntable ring assembly ③. Fit the raised, curved lines in the center of the glass tray bottom between the three spokes of the shaft. Make sure that the glass tray ① engages in the turntable shaft ② in the centre of the cooking compartment floor. The rollers on the shaft should fit inside the turntable bottom ridge.

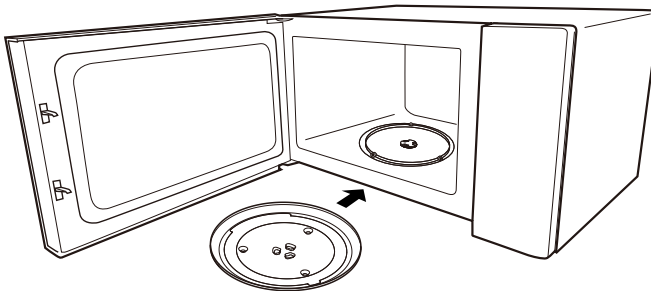

Note:

1. Never use the appliance without the turntable. Make sure that it is properly engaged. The turntable can turn clockwise or anti-clockwise.
2. Never place the glass tray upside down. The glass tray should never be restricted.
3. Both glass tray and turntable ring assembly must always be used during cooking.
4. All food and containers of food are always placed on the glass tray for cooking.
5. Never restrict the movement of the turntable.
6. If glass tray or turntable ring assembly cracks or breaks, contact your nearest authorized service center.

Installation Instructions

IMPORTANT SAFETY INSTRUCTION

The appliance must be disconnected from the source of supply before attempting the installation of the accessory.

Accessories

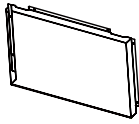

DUCT BOTTOM

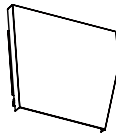

DUCT UPPER

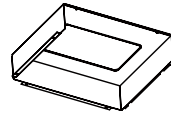

DUCT BACK



TRIM SASH



SCREW A



SCREW B

NO.	PART NANE	Q'TY
•	DUCT BOTTOM	1
•	DUCT UPPER	1
•	DUCT BACK	1
•	TRIM SASH	1
•	SCREW A	4
•	SCREW B	6

The dimension of the cupboard should be as belows (FIG.1).

Width : 22.44"(570mm) TOLERANCE $\pm 1/8"$.

Height : 15.14"(384.4mm) TOLERANCE $\pm 1/12"$.

Depth : at least 19.25" (488mm).

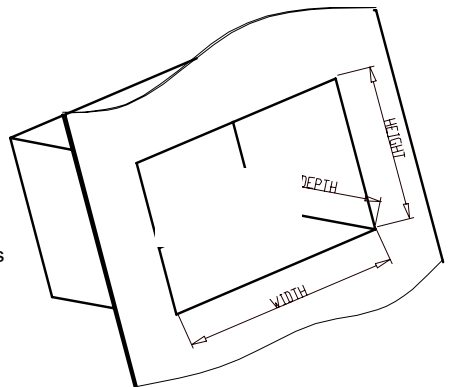

FIG.1

Step 1.CHECK THE TRIM SASH

Take out the trim sash from the packing box, and make sure the trim sash is the same showing as the FIG. 2.

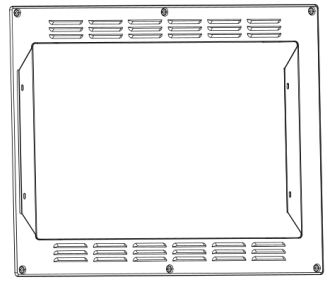

FIG.2

Step 2.CHECK THE AIR DUCTS

Take out the microwave oven from packing box, please check the duct upper, duct bottom, duct back if assembled as the showing of FIG3, and fasten the screws.

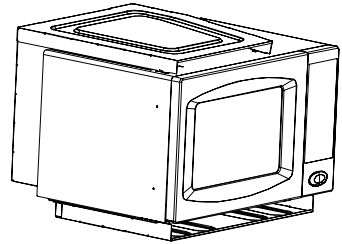

FIG.3

Step 3.TRIM SASH INSTALLATION

Fix assembled TRIM SASH to the Oven as shown in FIG.4

Use SCREW A to fasten the TRIM SASH ASSEMBLY at points indicated in FIG.4

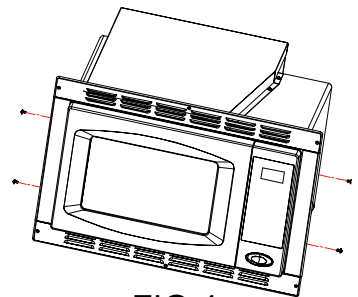

FIG.4

Step 4.MICROWAVE OVEN INSTALLATION

Slide Microwave Oven into the cupboard.

Secure the Oven to the cabinet with SCREW B at points indicated in FIG.5.

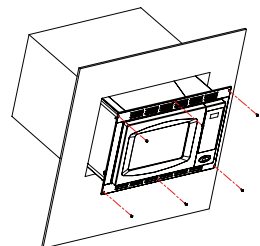
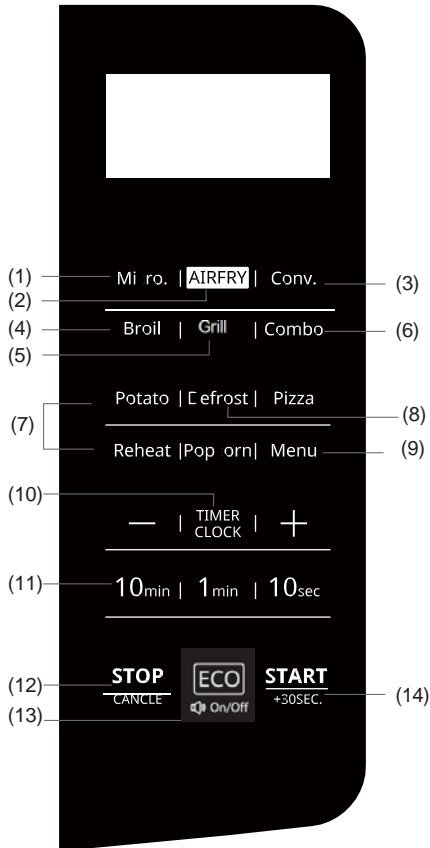

FIG5

OPERATION

Control Panel and Features



- (1) Micro.
- (2) AIRFRY
- (3) Conv.
- (4) Broil
- (5) Grill
- (6) Combo
- (7) Auto menu 1: Potato,Pizza, Reheat,Popcorn
- (8) Defrost
- (9) Auto menu 2: Menu
- (10) Timer/Clock
- (11) 10min/1min/10sec
- (12) Stop/Cancel: clears all previous setting pressed before cooking starts. During cooking: press once to stop oven; twice to stop and clear all entries.
- (13) ECO/ Sound on/off
- (14) Start/+30Sec.

OPERATION INSTRUCTION

1. Power Level

11 power levels are available.

Level	10	9	8	7	6	5	4	3	2	1	0
Power	100%	90%	80%	70%	60%	50%	40%	30%	20%	10%	0%
Display	PL10	PL9	PL8	PL7	PL6	PL5	PL4	PL3	PL2	PL1	PL0

2. Setting the Clock

After connecting the oven to the power, "0:00" shows on the display. Buzzer sounds.

- (1) Press "TIMER/CLOCK" twice and then "00:00" will display.
- (2) Press "10min", "1min", "10sec" to set the time, the range of the time should be within 1:00-12:59.
- (3) Press "TIMER/CLOCK" to confirm. The clock is set.

Notes:

- (a) In the process of clock setting, if the "STOP/CANCEL" button is pressed or if there is no operation within 1 minute, the oven will return to the former setting.
- (b) To reset the clock, please repeat step 1 to step 3.

3. Setting the Kitchen Timer

- (1) Press "TIMER/CLOCK" once and then "00:00" will display.
- (2) Press "10min", "1min", "10sec" to set the time, the range of the time should be within 00:10--99:50.
- (3) Press " START/+30SEC " to confirm. The timer starts counting down.

Notes:

- (a) Kitchen timer is a timer as an alarm clock.
- (b) In the timing state, the oven will not start with any program and the oven light will not light.

4. Microwave Cooking

- (1) Press "MICRO." and then "PL10" will display.
- (2) Press "MICRO." repeatedly or "-", "+" to set the power level. The 11 power levels are available.
- (3) Press "10min", "1min", "10sec" to set the cooking time. The maximum time value is "99:50".
- (4) Press "START/+30SEC." to start cooking.
Example: to cook the food with PL5 for 5 minute.
 - a. Press "MICRO."
 - b. Press "MICRO." repeatedly or "-", "+" to select PL5.
 - c. Press "1min" 5 times to set the time for 5 minutes..
 - d. Press "START/+30SEC." to start cooking.

Notes:

- (a) In standby state with the door closed, press "10min", "1min", "10sec" to cook with PL10 for the corresponding time.
- (b) Press "START/+30SEC." to increase the cook time.

5. Multi-Stage Cooking

Notes:

- (a) Two cooking stages can be set in multi-stage cooking.
- (b) If you set defrost function, it will work automatically in the first stage.
- (c) Kitchen Timer, auto menu, airfry, speed cooking, convection with preheat cannot be set for multi-stage cooking.

Example: defrost food for 3 minutes and then cook with 80% microwave power for 10 minutes

- (1) Press "Defrost" twice and then the screen will display "dEF2".
- (2) Press "1min" three times to set the desired defrost time of 3 minutes.
- (3) Press "MICRO." and then "PL10" will display.
- (4) Press "MICRO." repeatedly or press "-", "+" to set the power level of PL8.
- (5) Press "10min" once to set the cooking time of 10 minutes.
- (6) Press "START/+30SEC." to start cooking.

6. Air fry

- (1) Press "AIRFRY" and then "H-1" will display.
- (2) Press "AIRFRY" repeatedly or press "-", "+" to select menu from H-1 to H-9 .
- (3) Press "START/+30SEC." will display cooking weight
- (4) Press "START/+30SEC." to start cooking.

Air fry menu

Menu	Display	Weight	Cooking Time
Frozen French fries	H-1	9Oz	27:00
Frozen Potato croquettes	H-2	10Oz	18:00
Frozen Squid	H-3	7Oz	15:00
Frozen Onion rings	H-4	7Oz	15:00
Frozen chicken nuggets	H-5	12Oz	23:00
Escalope	H-6	13Oz	23:00
Shrimps	H-7	8Oz	20:00
Vegetable	H-8	6Oz	20:00
Chicken wings	H-9	16Oz	23:00

Notes: airfry cannot be set as one of the multi-stage cooking.

7. Conv. with preheating

- (1) In standby mode, press "Conv.", the oven will display "100°F".
- (2) Press "Conv." repeatedly or press "-" or "+" to adjust the temperature from 100 to 425°F.

10 options are available, including 100,150,250,275,300,325,350,375,400,425 (°F)
- (3) Press " START/+30SEC. " to start preheat .
- (4) When the preheat timer arrives, the Buzzer will beep two times.
- (5) Open and then close the door, press "10min", "1min", "10sec" to adjust the cooking time.
- (6) Press " START/+30SEC. " to start cooking.

Notes:

- (a) Cooking time cannot be input until the preheating temperature arrives. Once the temperature arrives, door must be opened and then closed to input the cooking time.

- (b) When the preheating temperature arrives, the Buzzer will beep five times and return to standby if the time is not input in 5 minutes,

8. Conv. without Preheating

- (1) In standby mode press “, Conv.” or once, the oven will display "100°F".
- (2) Press "Conv." repeatedly or press "-" or "+" to adjust the temperature from 100 to 425 °F.
10 options are available, including 100,150,250,275,300,325,350,375,400,425 (°F)
- (3) Press “10min”, “1min”, “10sec” to adjust the cooking time.
- (4) Press " START/+30SEC. " to start cooking.
- (5) When the cooking timer arrives, the Buzzer will beep five times and return to standby.

9. Grill

- (1) In standby state, press "Grill" once, the oven will display "G-1".
- (2) Press “10min”, “1min”, “10sec” to set the cooking time.
- (3) Press " START/+30SEC. " to start cooking .
- (4) When the cooking timer arrives, the Buzzer will beep five times and return to standby.
Note: Buzzer will sound twice to remind you to turn over the food when half of time has arrived.

10. Combination Cooking

- (1) Press “Combo” once, “G-2” will display.
- (2) Press “Combo” repeatedly or press "-" or "+" to choose the mode, G-2, G-3 and C-1 are available and display in order.
- (3) Press “10min”, “1min”, “10sec” to enter cooking time. The maximum time value is “99:50”.
- (4) Press “START/+30SEC.” to start cooking.

Instructions	Display	Microwave	Grill	Convection
1	G-2	●	●	
2	G-3	●	●	
3	C-1	●		●

11 Defrost

11.1 Defrost by weight

- (1) Press "Defrost" once and then the screen will display "dEF1".
- (2) Press "10min", "1min", "10sec" set the desired defrost weight. The range of weight is 4~100Oz.
- (3) Press "START/+30SEC." to start defrosting.
- (4) Once defrosting has finished, the buzzer will sound five times and return to standby.

Note: Buzzer will sound twice to remind you to turn over the food when 40 percent of time has arrived.

11.2 Defrost by time

- (1) Press "Defrost" twice and then the screen will display "dEF2".
- (2) Press "10min", "1min", "10sec" set the desired defrost time. The range of time is 0:10-99:50.
- (3) Press "START/+30SEC." to start defrosting.
- (4) Once defrosting has finished, the buzzer will sound five times and return to standby.

12. Speedy Cooking

- (1) In waiting state with the door closed, press "START/+30SEC." to cook food with PL10 power level for 30 seconds. Then you can press "START/+30SEC." to increase the cooking time. Once finished, the buzzer will sound five times and return to standby.
- (2) In waiting state with the door closed, pressing "10min", "1min", "10sec" to start cooking with correspond time with PL10 power level directly, Then you can press "START/+30SEC." to increase the cooking time. Once finished, the buzzer will sound five times and return to standby.

13. Auto menu 1

Potato

- (1) In waiting state, press "Potato" once, "1" will display, press "Potato" repeatedly or press "-", "+" to select the number of potato. "1", "2" and "3" will display in order. "1": one potato (approximate 8 Oz)
"2": two potatoes (approximate 16 Oz)
"3": three potatoes (approximate 24 Oz)
- (2) Press "START/+30SEC." to start cooking.

Pizza

- (1) In waiting state, Press "Pizza" once, "10" will display, press "Pizza" repeatedly or press "-", "+" to select the weight of pizza. "10" and "14" Oz will display in order.
- (2) Press "START/+30SEC." to start cooking.

Reheat

- (1) In waiting state, press "Reheat" once, then press "Reheat" repeatedly or press "-", "+" to select the weight of reheat you want. "5", "8", "12", "15" and "21" Oz will display in order.
- (2) Press "START/+30SEC." to start cooking.

Popcorn

- (1) In waiting state, press "Popcorn" once, "2.75" will display, then press "Popcorn" repeatedly or press "-", "+" to select the weight of popcorn you want. "2.75" "3.2" and "3.5" Oz will display in order.
- (2) Press "START/+30SEC." to start cooking.

Notes:

- (a) auto menu 1 cannot be set as one of the multi-stage cooking.
- (b) In the process of auto menu 1, you can not press "START/+30SEC." to increase the cooking time

14. Auto menu 2

- (1) Press "Menu" and then "A-1" will flash.
- (2) Press "Menu" repeatedly or "-", "+" to select the menu you need. 7 auto menus are available.
- (3) Press "START/+30SEC." to confirm. (default minimum weight)
- (4) Press "-", "+" repeatedly to set the desired weight of food.
- (5) Press "START/+30SEC." to start cooking.

Notes:

- (a) Auto menu 2 cannot be set as one of the multi-stage cooking.
- (b) In the process of auto menu 2, you can not press "START/+30SEC." to increase the cooking time

Auto Menu 2 Chart

Menu	Weight	Display	Cooking time
A-1 MEAT	4 Oz	4 Oz	2'50"
	8 Oz	8 Oz	4'30"
	16 Oz	16 Oz	6'10"
	22 Oz	22 Oz	7'50"
A-2 Fresh VEGETABLE	4 Oz	4 Oz	2'10"
	8 Oz	8 Oz	4'00"
	16 Oz	16 Oz	5'30"
A-3 Frozen Vegetable	4 Oz	4 Oz	3'00"
	8 Oz	8 Oz	5'00"
	16 Oz	16 Oz	7'00"
A-4 FISH	4 Oz	4 Oz	2'50"
	8 Oz	8 Oz	4'00"
	12 Oz	12 Oz	5'10"
	16 Oz	16 Oz	6'20"
	22 Oz	22 Oz	8'40"
A-5 PASTA	1.75 Oz (cold water 16 Oz)	1.75 Oz	18'00"
	3.5Oz (cold water 28 Oz)	3.5 Oz	20'00"
	5.5Oz(cold water 42 Oz)	5.5 Oz	22'00"
A-6 Beverage	One cup(120ML)	1	1'00"
	Two cup(240ML)	2	1'40"
	Three cup(360ML)	3	2'20"
A-7 CAKE	16 Oz	16 Oz	50'00"

15. Broil/Crispy Grill

- (1) In standby mode, press "Broil" once, the oven will display "C-1".
- (2) Press "broil" repeatedly or "-", "+" to select the menu you need. "C-1"~"C-4" are available.
- (3) Press "START/+30SEC." to confirm.
- (4) Press "-", "+" repeatedly to set the desired weight of food.
- (5) Press " START/+30SEC. " to start cooking

Notes:

- (a) Broil cannot be set as one of the multi-stage cooking.
- (b) In the process of broil, you can not press "START/+30SEC." to increase the cooking time

Menu	Weight	Cooking time
C1 Cordon bleu	7.00Oz	17:00
	10.50Oz	18:00
	14.00Oz	19:00
	18.00Oz	20:00
	21.00Oz	21:00
C2 (lasagna)	7.00Oz	11:00
	10.50Oz	13:00
	14.00Oz	15:00
	18.00Oz	17:00
	21.00Oz	19:00
C3 (frozen bread)	3.50Oz	12:00
	7.00Oz	13:30
	10.50Oz	15:00
C4 (pie/tart)	7.00Oz	14:00
	10.50Oz	15:00
	14.00Oz	16:00
	18.00Oz	17:00

16. ECO Function

In standby state, press “ECO” once and the LED display will become darker. Press twice, it will become more lighter, and press three times, the LED display will be off.

When the LED display stays off, press any function button once or open the door it can return to normal status. And press function button twice will enter the correspond cooking program.

17. Sound on/off

- (1) In standby state, press “ECO” for 3 seconds, then the oven will display “OFF” for one second and the buzzer will be off.
- (2) In standby state with buzzer off, press “ECO” for 3 seconds, then the oven will display “On” for one second and the buzzer will be on.

Note: Sound on/off does not have power-off memory function.

18. Lock Function for Children

You can use this function to prevent children from accidentally turning the oven on.

18.1 To activate the lock:

In waiting state, press and hold “STOP/CANCLE” for 3 seconds. A long beep sounds and the locked icon will display,

18.2 To deactivate the lock:

In locked state, press and hold “STOP/CANCLE” for 3 seconds. A long beep sounds.

Maintenance

Troubleshooting

Check your problem by referencing the chart below and trying the solutions for each problem.

If the microwave oven still does not work properly, contact the nearest authorized service center.

TROUBLE	POSSIBLE CAUSE	POSSIBLE REMEDY
Oven will not start	<ul style="list-style-type: none"> a. Electrical cord for oven is not plugged in. b. Door is open. c. Wrong operation is set. 	<ul style="list-style-type: none"> a. Plug into the outlet. b. Close the door and try again. c. Check instructions.
Arcing or sparking	<ul style="list-style-type: none"> a. Materials to be avoided in microwave oven were used. See page 6. b. The oven is operated when empty. c. Spilled food remains in the cavity. 	<ul style="list-style-type: none"> a. Use microwave-safe cookware only. b. Do not operate with oven empty. c. Clean cavity with wet towel.
Unevenly cooked foods	<ul style="list-style-type: none"> a. Materials to be avoided in microwave oven were used. See page 6. b. Food is not defrosted completely. c. Cooking time, power level is not suitable. 	<ul style="list-style-type: none"> a. Use microwave-safe cookware only. b. Completely defrost food. c. Use correct cooking time, power level. d. Turn or stir food.
Overcooked foods	Cooking time, power level is not suitable.	Use correct cooking time, power level.
Undercooked foods	<ul style="list-style-type: none"> a. Materials to be avoided in microwave oven were used. See page 6. b. Food is not defrosted completely. c. Oven ventilation ports are restricted. d. Cooking time, power level 	<ul style="list-style-type: none"> a. Use microwave-safe cookware only. b. Completely defrost food. c. Check to see that oven ventilation ports are not restricted. d. Use correct cooking
Improper defrosting	<ul style="list-style-type: none"> a. Materials to be avoided in microwave oven were used. See page 6. b. Cooking time, power level is not suitable. c. Food is not turned or stirred. 	<ul style="list-style-type: none"> a. Use microwave-safe cookware only. b. Use correct cooking time, power level. c. Turn or stir food.